

Article number: 0101069
 Description: Retaining ring A 52 DIN 471
 Spring steel
 Note: Fitted with ZGA pilers

Measures

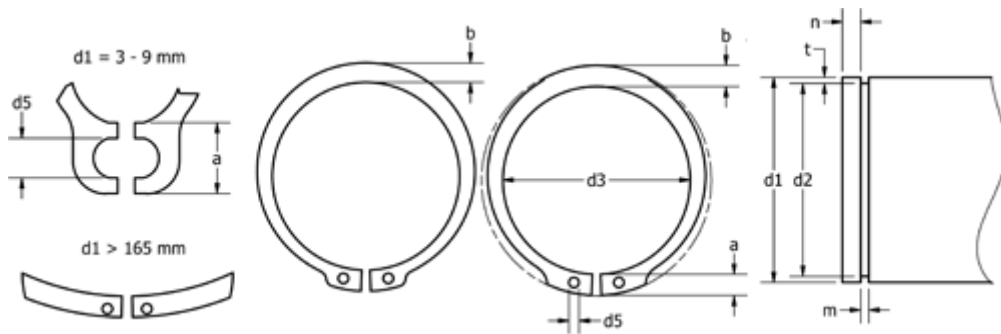

a max	= 7.0	FN kN	= 39.7	s	= 2.00
AN mm ²	= 238.0	FRg kN	= 11.50	t	= 1.50
b	= 5.2	FR kN	= 73.10	tol	= -0.25
d1	= 52	g	= 2.5	tol	= -0.07
d2	= 49.0	K kN-mm	= 133.00	tol	= +0,39-0,90
d3	= 47.8	m min	= 2.15	Tong	= ZGA-3
d5 min	= 2.5	n abl x 1000	= 10.0	Weight kg/1000	= 11.100
Description	= A52	Nominal drive	= 4.5		